

# Data Sheet



Article number: 02150000038

Description: Sealing Clamp S 38 W1

## Measures

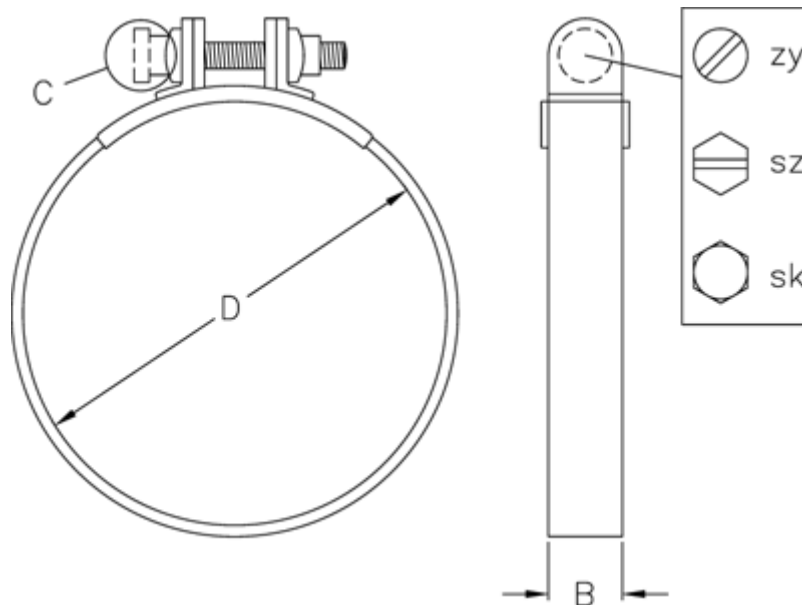

C (screw type) = SZ

Diameter D = 38

Width B = 20